

METAL TRAYS AND WIRE MESH TRAYS

ZAM3K
FINISHING

EZ1000
FINISHING

BE Basor
CABLE TRAY SPECIALIST

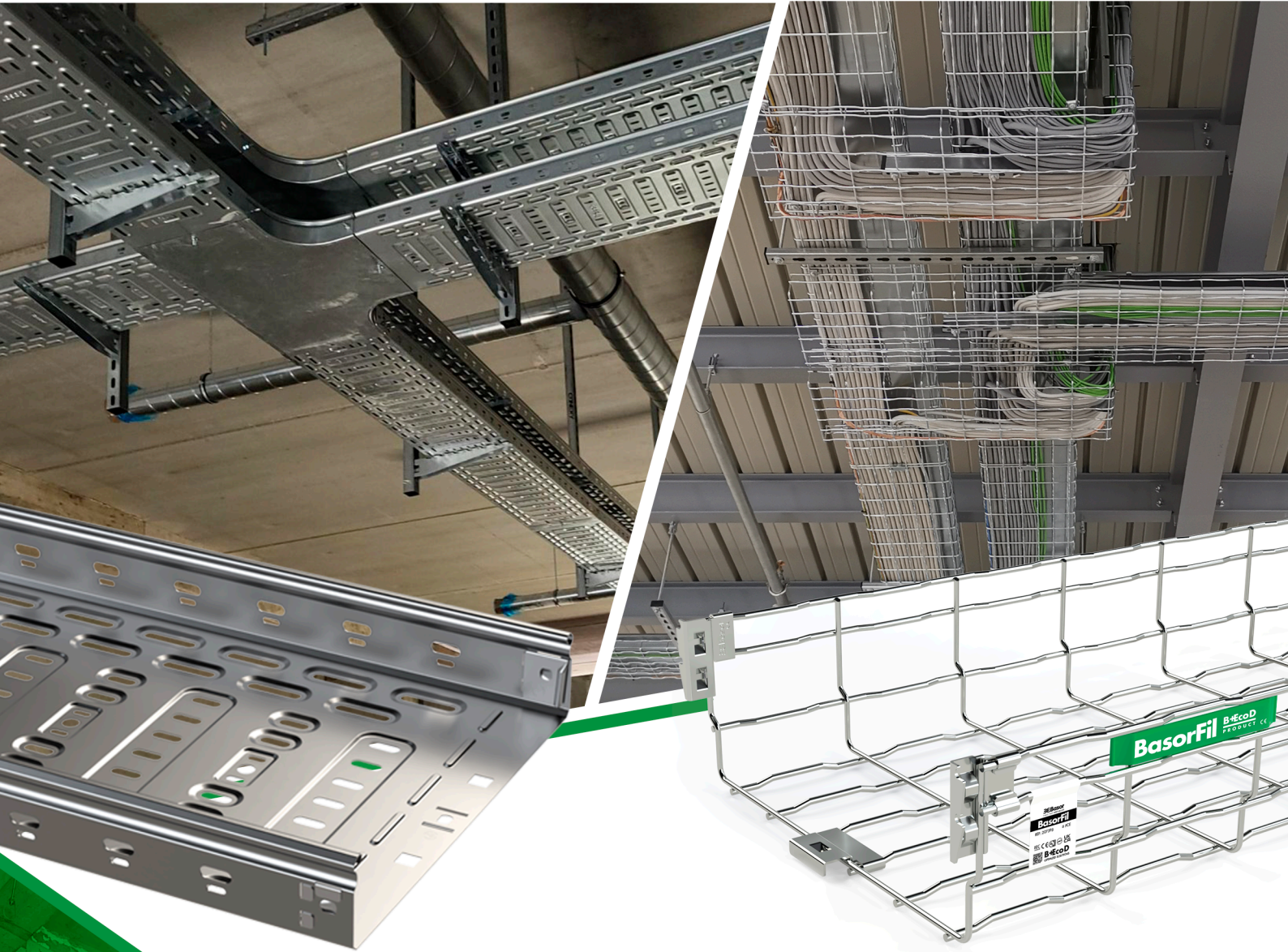

HCR 8+

C8+ HIGH CORROSION RESISTANCE FINISHES



B+EcoD

OPTIMIZED IMPACT
SOLUTIONS

Recommended for:

General installations where fast assembly is required, thanks to a system with no screws or splice connectors between tray sections. Designed for low to medium corrosive environments, it stands out for its excellent strength-to-cost ratio and its complete range of formed accessories, which simplify installation without damaging cables or requiring on-site fabrication.

Modelos:

Models (WxH): 100x60; 150x60; 200x60; 300x60; 400x60; 500x60; 600x60.
100x75; 150x75; 200x75; 300x75; 400x75; 500x75; 600x75.

Finishes: PG (Pre-Galvanized Steel – Sendzimir); HDG (Hot-Dip Galvanized); ZAM3K (High-Resistance Zn-Al-Mg Pre-Galvanized Finish).

BASORTRAY NR2E Cable Tray Characteristics

UNE-EN 61537

- Metallic system
- Impact resistance: 20 J
- Minimum temperature: -50 °C
- Maximum temperature: 150 °C
- Flame retardant
- Electrical continuity system
- Electrically conductive component
- Metallic coating corrosion resistance:
 - PG coating: Class 3
 - HDG coating: Class 5
 - ZAM3K coating: Class 8+ (>3000 h Salt Spray Test)
 - AISI 304 Stainless Steel: Class 9A
- Base perforation classification:
 - Solid bottom tray: Classification A
 - Perforated tray: Classification C, except 100 mm bottom width, which is Classification B

BASORTRAY NR2E Trunking + Cover Characteristics

UNE-EN 50085

- Metallic system
- Impact resistance: 20 J
- Minimum storage temperature: -45 °C
- Minimum installation temperature: -25 °C
- Maximum temperature: 120 °C
- Flame retardant
- Electrical continuity system
- No electrical insulation
- Degree of protection:
 - Solid NR2E + TNR2E cover: IP44
 - Perforated NR2E + TNR2E cover: IP23
 - IK07 without clip
 - IK10 with PTNRE retaining clip
- Medium internal and external protection against corrosive substances for PG finish; high internal and external protection for PGP finish (upon request).
- Cover can be opened without tools, except in installations using the NR2E + PTNRE cover clip.
- Optional internal separation partition available for additional protection and circuit segregation.

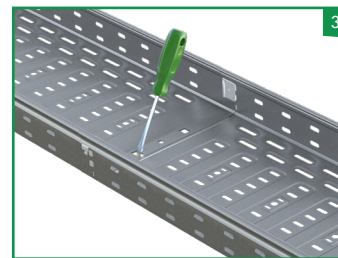
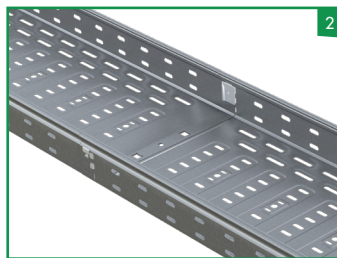
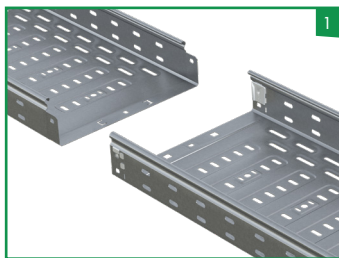

NX2E



60



100

	B		H		REF.
	mm	inch	mm	inch	
NE2E 100X60	100	4"	60	2 3/8"	228213
NE2E 150X60	150	6"	60	2 3/8"	228214
NE2E 200X60	200	8"	60	2 3/8"	228215
NE2E 300X60	300	12"	60	2 3/8"	228216
NR2E 400X60	400	16"	60	2 3/8"	228204
NR2E 500X60	500	20"	60	2 3/8"	228205
NR2E 600X60	600	24"	60	2 3/8"	228206

NE2E 100X100	100	4"	100	4"	228217
NR2E 150X100	150	6"	100	4"	228218
NE2E 200X100	200	8"	100	4"	228219
NE2E 300X100	300	12"	100	4"	228220
NR2E 400X100	400	16"	100	4"	228210
NR2E 500X100	500	20"	100	4"	228211
NR2E 600X100	600	24"	100	4"	228212

ZAM3K

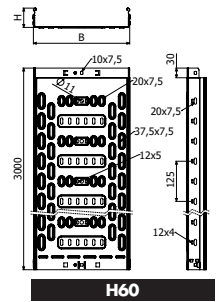

H60

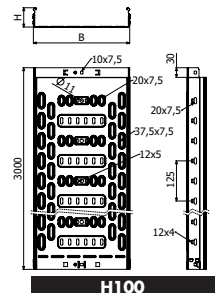

H100

NX2E-C



60



100

	B		H		REF.
	mm	inch	mm	inch	
NE2E-C 100X60	100	4"	60	2 3/8"	227981
NE2E-C 150X60	150	6"	60	2 3/8"	227982
NE2E-C 200X60	200	8"	60	2 3/8"	227983
NE2E-C 300X60	300	12"	60	2 3/8"	228736
NR2E-C 400X60	400	16"	60	2 3/8"	227985
NR2E-C 500X60	500	20"	60	2 3/8"	227986
NR2E-C 600X60	600	24"	60	2 3/8"	228761

NE2E-C 100X100	100	4"	100	4"	228737
NE2E-C 150X100	150	6"	100	4"	228738
NE2E-C 200X100	200	8"	100	4"	228739
NE2E-C 300X100	300	12"	100	4"	228740
NR2E-C 400X100	400	16"	100	4"	227991
NR2E-C 500X100	500	20"	100	4"	227992
NR2E-C 600X100	600	24"	100	4"	228762

ZAM3K

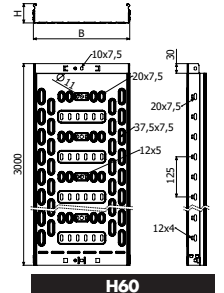

H60

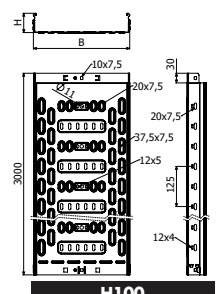

H100

TNRE

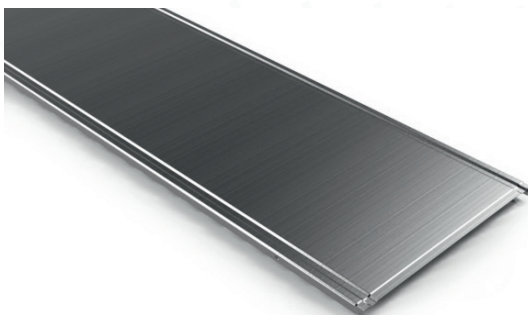

	B		REF.
	mm	inch	
TNRE 100 3M	100	4"	227974
TNRE 150 3M	150	6"	227975
TNRE 200 3M	200	8"	227976
TNRE 300 3M	300	12"	227977
TNRE 400 3M	400	16"	227978
TNRE 500 3M	500	20"	227979
TNRE 600 3M	600	24"	227980

ZAM3K

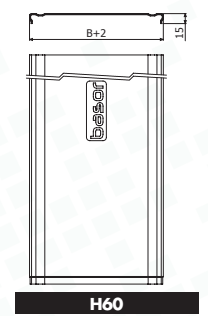

H60

B+EcoD OPTIMIZED IMPACT SOLUTIONS **FAST INSTALLATION**

B+EcoD OPTIMIZED IMPACT SOLUTIONS **FAST INSTALLATION**



CPNRE

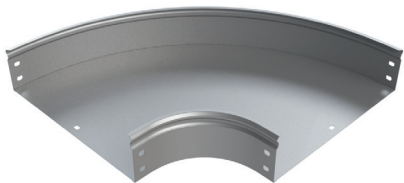

	B		H		REF.
	mm	inch	mm	inch	
CPNRE 100X60	100	4"	60	2 3/8"	228221
CPNRE 150X60	150	6"	60	2 3/8"	228222
CPNRE 200X60	200	8"	60	2 3/8"	228223
CPNRE 300X60	300	12"	60	2 3/8"	228224
CPNRE 400X60	400	16"	60	2 3/8"	228225
CPNRE 500X60	500	20"	60	2 3/8"	228226
CPNRE 600X60	600	24"	60	2 3/8"	228227
CPNRE 100X100	100	4"	100	4"	228228
CPNRE 150X100	150	6"	100	4"	228229
CPNRE 200X100	200	8"	100	4"	228230
CPNRE 300X100	300	12"	100	4"	228231
CPNRE 400X100	400	16"	100	4"	228232
CPNRE 500X100	500	20"	100	4"	228233
CPNRE 600X100	600	24"	100	4"	228234

ZAM3K

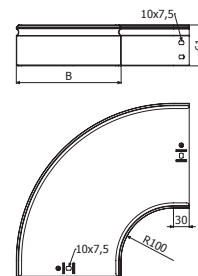

🔧 B = 100>300 -> 2x JUNRE (H60 224217 / H75 224218)
 B = 400>600 -> 2x JUNRE (H60 224217 / H75 224218) +1X JUNRE-C (224252)

TCPNRE

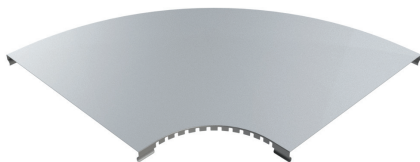

	B		REF.
	mm	inch	
TCPNRE 100	100	4"	228249
TCPNRE 150	150	6"	228250
TCPNRE 200	200	8"	228251
TCPNRE 300	300	12"	228252
TCPNRE 400	400	16"	228253
TCPNRE 500	500	20"	228254
TCPNRE 600	600	24"	228255

ZAM3K

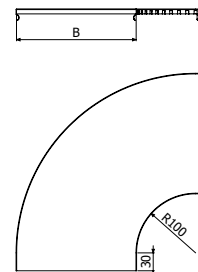

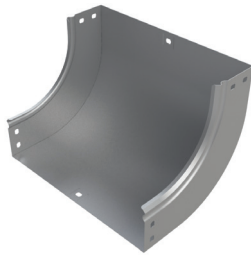

CCNRE

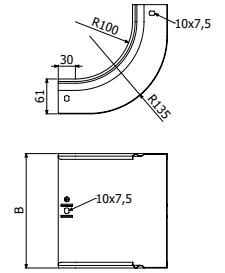

	B		H		REF.
	mm	inch	mm	inch	
CCNRE 100X60	100	4"	60	2 3/8"	228263
CCNRE 150X60	150	6"	60	2 3/8"	228264
CCNRE 200X60	200	8"	60	2 3/8"	228265
CCNRE 300X60	300	12"	60	2 3/8"	228266
CCNRE 400X60	400	16"	60	2 3/8"	228267
CCNRE 500X60	500	20"	60	2 3/8"	228268
CCNRE 600X60	600	24"	60	2 3/8"	228269
<hr/>					
CCNRE 100X100	100	4"	100	4"	228270
CCNRE 150X100	150	6"	100	4"	228271
CCNRE 200X100	200	8"	100	4"	228272
CCNRE 300X100	300	12"	100	4"	228273
CCNRE 400X100	400	16"	100	4"	228274
CCNRE 500X100	500	20"	100	4"	228275
CCNRE 600X100	600	24"	100	4"	228276

ZAM3K



 B = 100>300 -> 2x JUNRE (H60 224217 / H100 224218)
 B = 400>600 -> 2x JUNRE (H60 224217 / H100 224218) +1X JUNRE-C (224252)

TCCNRE

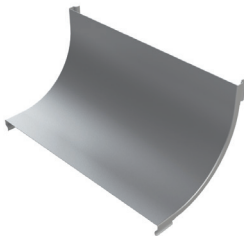

	B		REF.
	mm	inch	
TCCNRE 100	100	4"	228291
TCCNRE 150	150	6"	228292
TCCNRE 200	200	8"	228293
TCCNRE 300	300	12"	228294
TCCNRE 400	400	16"	228295
TCCNRE 500	500	20"	228296
TCCNRE 600	600	24"	228297

ZAM3K

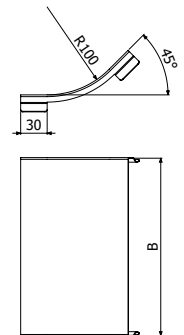

CXNRE

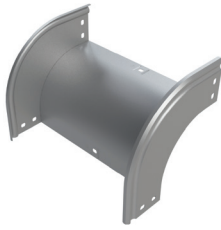

	B		H		REF.
	mm	inch	mm	inch	
CXNRE 100X60	100	4"	60	2 3/8"	228305
CXNRE 150X60	150	6"	60	2 3/8"	228306
CXNRE 200X60	200	8"	60	2 3/8"	228307
CXNRE 300X60	300	12"	60	2 3/8"	228308
CXNRE 400X60	400	16"	60	2 3/8"	228309
CXNRE 500X60	500	20"	60	2 3/8"	228310
CXNRE 600X60	600	24"	60	2 3/8"	228311
<hr/>					
CXNRE 100X100	100	4"	100	4"	228312
CXNRE 150X100	150	6"	100	4"	228313
CXNRE 200X100	200	8"	100	4"	228314
CXNRE 300X100	300	12"	100	4"	228315
CXNRE 400X100	400	16"	100	4"	228316
CXNRE 500X100	500	20"	100	4"	228317
CXNRE 600X100	600	24"	100	4"	228318

ZAM3K

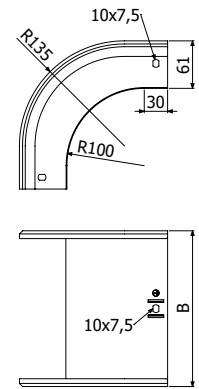

B = 100>300 -> 2x JUNRE (H60 224217 / H75 224218)
B = 400>600 -> 2x JUNRE (H60 224217 / H75 224218) +1X JUNRE-C (224252)

TCXNRE

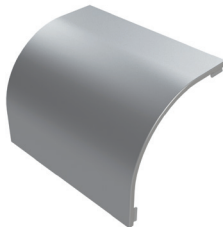

	B		REF.
	mm	inch	
TCXNRE 100X60	100	4"	228333
TCXNRE 150X60	150	6"	228334
TCXNRE 200X60	200	8"	228335
TCXNRE 300X60	300	12"	228336
TCXNRE 400X60	400	16"	228337
TCXNRE 500X60	500	20"	228338
TCXNRE 600X60	600	24"	228339
<hr/>			
TCXNRE 100X100	100	4"	228340
TCXNRE 150X100	150	6"	228341
TCXNRE 200X100	200	8"	228342
TCXNRE 300X100	300	12"	228343
TCXNRE 400X100	400	16"	228344
TCXNRE 500X100	500	20"	228345
TCXNRE 600X100	600	24"	228346

ZAM3K

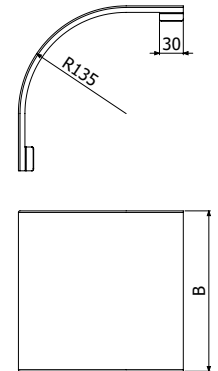

TENRE

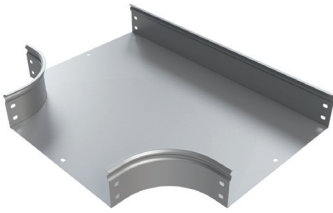

	B		H		REF.
	mm	inch	mm	inch	
TENRE 100X60	100	4"	60	2 3/8"	228361
TENRE 150X60	150	6"	60	2 3/8"	228362
TENRE 200X60	200	8"	60	2 3/8"	228363
TENRE 300X60	300	12"	60	2 3/8"	228364
TENRE 400X60	400	16"	60	2 3/8"	228365
TENRE 500X60	500	20"	60	2 3/8"	228366
TENRE 600X60	600	24"	60	2 3/8"	228367

TENRE 100X100	100	4"	100	4"	228368
TENRE 150X100	150	6"	100	4"	228369
TENRE 200X100	200	8"	100	4"	228370
TENRE 300X100	300	12"	100	4"	228371
TENRE 400X100	400	16"	100	4"	228372
TENRE 500X100	500	20"	100	4"	228373
TENRE 600X100	600	24"	100	4"	228374

ZAM3K

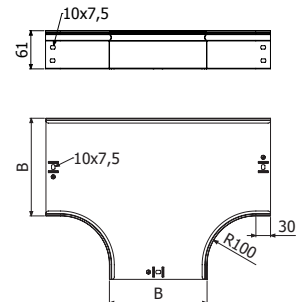

🔧 B = 100>300 > 2x JUNRE (H60 224217 / H75 224218)
B = 400>600 > 2x JUNRE (H60 224217 / H75 224218) + 1X JUNRE-C (224252)

TENRE

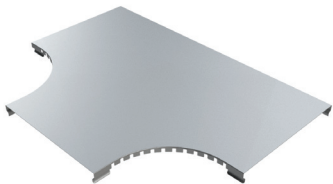

	B		REF.
	mm	inch	
TTENRE 100	100	4"	228375
TTENRE 150	150	6"	228376
TTENRE 200	200	8"	228377
TTENRE 300	300	12"	228378
TTENRE 400	400	16"	228379
TTENRE 500	500	20"	228380
TTENRE 600	600	24"	228381

TTENRE 100	100	4"	228375
TTENRE 150	150	6"	228376
TTENRE 200	200	8"	228377
TTENRE 300	300	12"	228378
TTENRE 400	400	16"	228379
TTENRE 500	500	20"	228380
TTENRE 600	600	24"	228381

ZAM3K

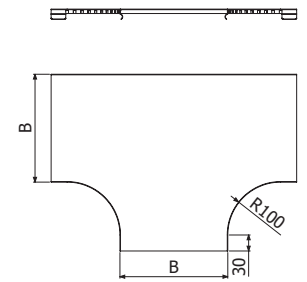

CRNRE

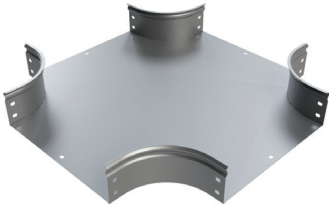

	B		H		REF.
	mm	inch	mm	inch	
CRNRE 100X60	100	4"	60	2 3/8"	228382
CRNRE 150X60	150	6"	60	2 3/8"	228383
CRNRE 200X60	200	8"	60	2 3/8"	228384
CRNRE 300X60	300	12"	60	2 3/8"	228385
CRNRE 400X60	400	16"	60	2 3/8"	228386
CRNRE 500X60	500	20"	60	2 3/8"	228387
CRNRE 600X60	600	24"	60	2 3/8"	228388
<hr/>					
CRNRE 100X100	100	4"	100	4"	228389
CRNRE 150X100	150	6"	100	4"	228390
CRNRE 200X100	200	8"	100	4"	228391
CRNRE 300X100	300	12"	100	4"	228392
CRNRE 400X100	400	16"	100	4"	228393
CRNRE 500X100	500	20"	100	4"	228394
CRNRE 600X100	600	24"	100	4"	228395

ZAM3K

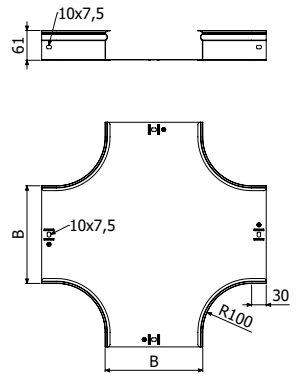

B = 100>300 -> 2x JUNRE (H60 224217 / H75 224218)
 B = 400>600 -> 2x JUNRE (H60 224217 / H75 224218) + 1X JUNRE-C (224252)

TCRNRE

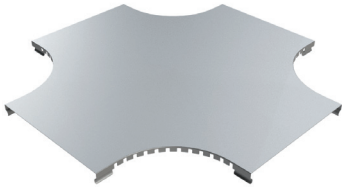

	B		REF.
	mm	inch	
TCRNRE 100	100	4"	228396
TCRNRE 150	150	6"	228397
TCRNRE 200	200	8"	228398
TCRNRE 300	300	12"	228399
TCRNRE 400	400	16"	228400
TCRNRE 500	500	20"	228401
TCRNRE 600	600	24"	228402

ZAM3K

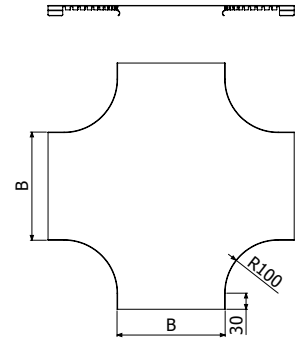

ASNRE

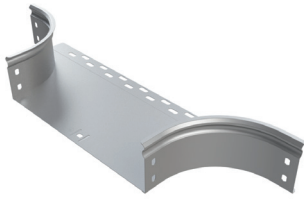

	B		H		REF.
	mm	inch	mm	inch	
ASNRE 100X60	100	4"	60	2 3/8"	228409
ASNRE 150X60	150	6"	60	2 3/8"	228410
ASNRE 200X60	200	8"	60	2 3/8"	228411
ASNRE 300X60	300	12"	60	2 3/8"	228412
ASNRE 400X60	400	16"	60	2 3/8"	228413
ASNRE 500X60	500	20"	60	2 3/8"	228414
ASNRE 600X60	600	24"	60	2 3/8"	228415
<hr/>					
ASNRE 100X100	100	4"	100	4"	228416
ASNRE 150X100	150	6"	100	4"	228417
ASNRE 200X100	200	8"	100	4"	228418
ASNRE 300X100	300	12"	100	4"	228419
ASNRE 400X100	400	16"	100	4"	228420
ASNRE 500X100	500	20"	100	4"	228421
ASNRE 600X100	600	24"	100	4"	228422

ZAM3K

B = 100-300 > 2x JUNRE (H60 224217 / H75 224218)
 B = 400-600 > 2x JUNRE (H60 224217 / H75 224218) +1X JUNRE-C (224252)

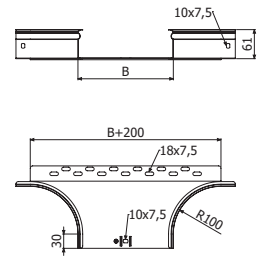

TASNRE

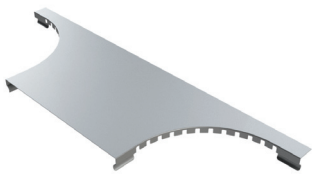

	B		REF.
	mm	inch	
TASNRE 100	100	4"	228423
TASNRE 150	150	6"	228424
TASNRE 200	200	8"	228425
TASNRE 300	300	12"	228426
TASNRE 400	400	16"	228427
TASNRE 500	500	20"	228428
TASNRE 600	600	24"	228429

ZAM3K

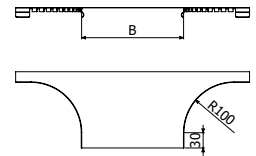

PTNRE



	H		REF.	i304
	mm	inch		
PTNRE 100x60	60	2 3/8"	224848	
PTNRE 150-600x60	60	2 3/8"	224849	
PTNRE 100x100	100	4"	228771	
PTNRE 150-600x100	100	4"	228772	

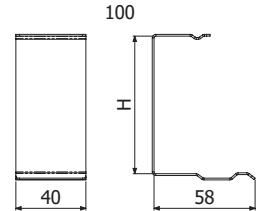
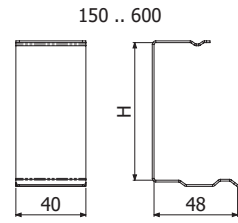

RENRE

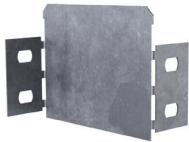

	B		H		REF.	ZAM3K
	mm	inch	mm	inch		
RENRE 50X60	50	2"	60	2 3/8"	228430	
RENRE 100X60	100	4"	60	2 3/8"	228431	
RENRE 50x100	50	2"	100	4"	228432	
RENRE 100X100	100	4"	100	4"	228433	

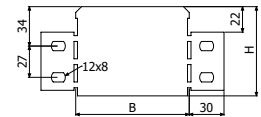

PS

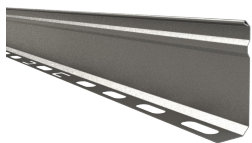

L = 3 m (10 ft)

	H		REF.	ZAM3K
	mm	inch		
PS 60	60	2 3/8"	226523	
PS 100	100	4"	226524	

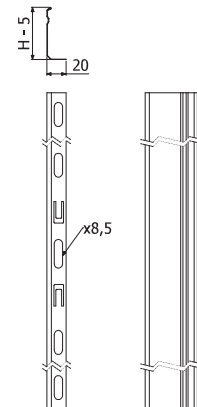
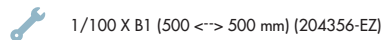

STANDARD UNION JOINTS



JUNRE



JUNRE-A



JUNRE-B



JUNRE-C

	H		REF.
	mm	inch	
JUNRE 60	60	2 3/8"	228403
JUNRE 100	100	4"	228404
JUNRE-A 60	60	2 3/8"	228405
JUNRE-A 100	100	4"	228406
JUNRE-B 60	60	2 3/8"	228407
JUNRE-B 100	100	4"	228408
JUNRE-C	75	3"	228434

ZAM3K

🔧 H60 -> 2/100 x B1 // H75 -> 4/100 x B1 (204356-EZ)

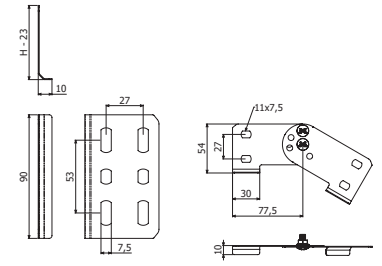

JUNRE

JUNRE-A

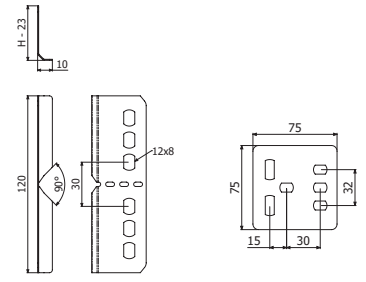

JUNRE-B

JUNRE-B

UNIVERSAL UNION JOINT



	H		REF.
	mm	inch	
JUNRE-U 60	60	2 3/8"	228443
JUNRE-U 100	100	4"	228444

ZAM3K

🔧 2/100 x B1 (204356 - EZ)

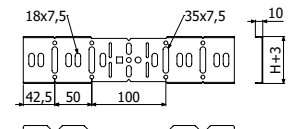

H60

JUNRE-U

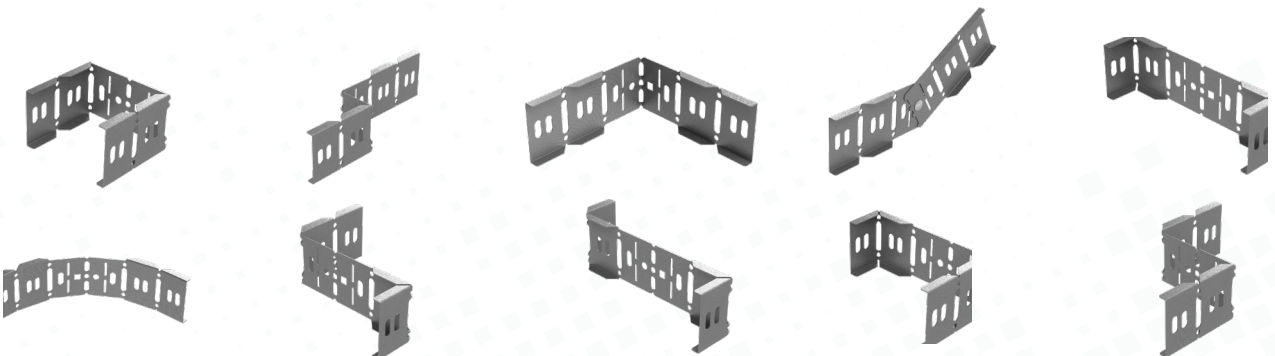
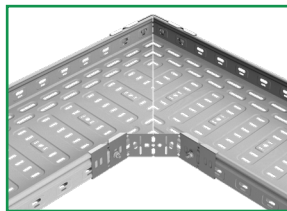

ACNRE

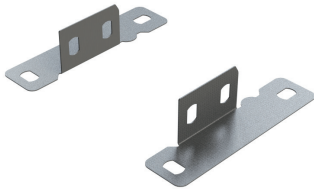

	B		REF.	ZAM3K
	mm	inch		
ACNRE H100	100	4"	228442	

4/100 x B1 - (204356-EZ)

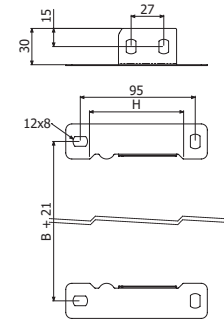
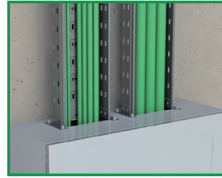

SCERC



	REF.	RLH
SCERC 1 KG	228442	

1 x ISO7380-2 M6X10 (100u-Pack: 226133-i304)
 B= 60-150 --> 1 x SCERC
 B= 200 --> 1 x SCERC Alternate position
 B= 300 - 600 --> 2 x SCERC

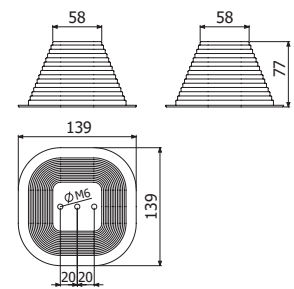
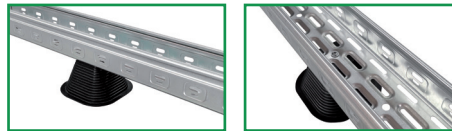

PBCH



	e	L	REF.	PVC
	mm	m		
PBCH 1MM	≤1	20	228442	
PBCH 1.5-4MM	≤4	20	228442	

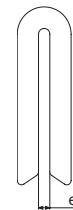
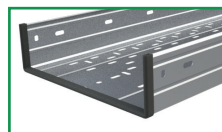

ISO7380-2



		P	M	L	H	Dext	s	REF.	
		N·m	mm	mm	mm	mm	mm		
ISO7380-2-100 Pack M6X10	100u	8	6	10	3,3	13,6	4	226133	i304

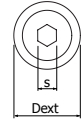
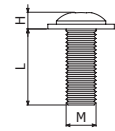

ISO 7380-2

B1



		Pap	L	REF.	
		N·m	mm		
B1-100 Pack	100u	20	6	204925	i304

		L	REF.	
		mm	N·m	
B1-100 Pack	100u	14	6	206826

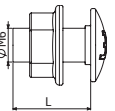

TT / TTL

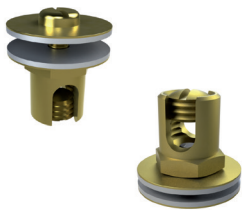

TT

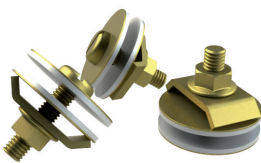

TTL

	Smin	Smax	Dcable	A	B	REF.	
	mm ²	mm ²	mm	mm	mm		
TT 4-35	4	35	2,2 α 8	22	18	204925	LTN
TT 35-95	35	95	8 α 12	30	24		
TTL 10-35	10	35	4 α 8	25	-		

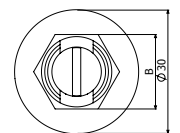
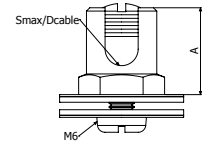

TT

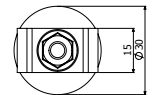
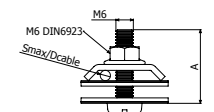

TTL



B+EcoD | OPTIMIZED IMPACT SOLUTIONS

Recommended for:

Designed for general low-load installations, these trays are suitable for medium to highly corrosive environments depending on the selected finish. Their key feature is versatility, enabling installers to cut and shape the routing according to project needs while ensuring maximum cable ventilation.

Models:

Models (WxH): 60x65; 100x65; 150x65; 200x65; 300x65; 400x65; 500x65; 600x65; 100x105; 150x105; 200x105; 300x105; 400x105; 500x105; 600x105

Finishes: Cincado EZ, Cincado EZ1000, Inoxidable i304

BASORFIL BF2R Cable Tray Characteristics

UNE-EN 61537:2007

- Metallic system
- Flame retardant
- Electrical continuity system
- Electrically conductive component
- Minimum temperature: -50 °C
- Maximum temperature: 150 °C
- Metallic coating corrosion resistance:
 - EZ electrozinc coating: Class 3
 - EZ1000 electrozinc coating: Class 8+
 - AISI 304 stainless steel: Class 9C
- Compliant with RoHS Directive 2011/65/EU

BasorFil BF2R

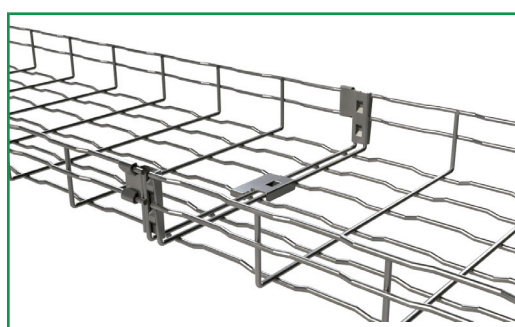
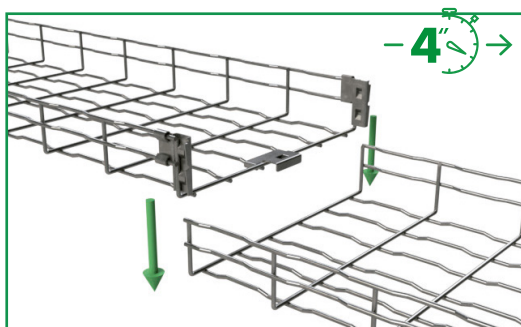

BF2R H65



BF2R2F 60x65



BF2R
L = 3 m (10 ft)

	B		B			REF.
	mm	inch	mm	inch		
BF2R-2F 60X65	60	2"	65	2"	0	217354
BF2R 100X65	100	4"	65	2"	0	217355
BF2R 150X65	150	6"	65	2"	0	217356
BF2R 200X65	200	8"	65	2"	1	217357
BF2R 300X65	300	12"	65	2"	1	217358
BF2R 400X65	400	16"	65	2"	1	217359
BF2R 500X65	500	20"	65	2"	2	217361
BF2R 600X65	600	24"	65	2"	2	217362

EZ 1000

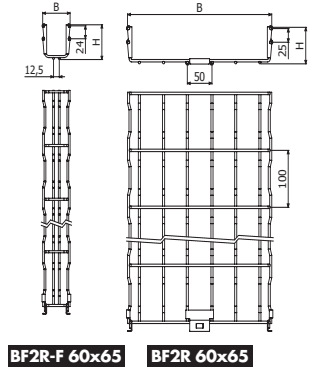

BF2R-F 60x65

BF2R 60x65



B+EcoD

OPTIMIZED IMPACT SOLUTIONS

FAST INSTALLATION

TNRE

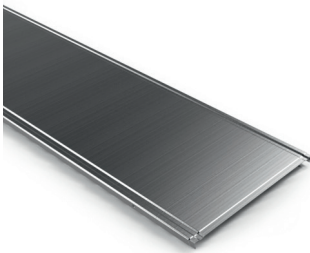

	B		REF.
	mm	inch	
TNRE 60 3M	60	2"	228793
TNRE 100 3M	100	4"	227974
TNRE 150 3M	150	6"	227975
TNRE 200 3M	200	8"	227976
TNRE 300 3M	300	12"	227977
TNRE 400 3M	400	16"	227978
TNRE 500 3M	500	20"	227979
TNRE 600 3M	600	24"	227980

ZAM3K

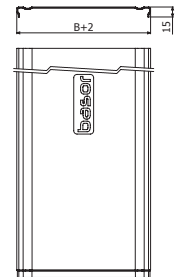

PTBFR



PTBFR



4 x PTBFR => 1 x TERE (BF2R/BFR)

REF.
227974

304

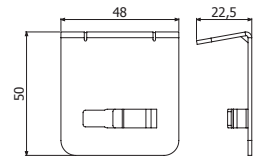
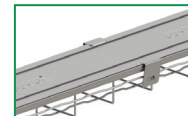

PS

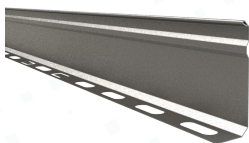

L = 3 m (10 ft)

	H		REF.
	mm	inch	
PS 60	60	2 3/8"	226523
PS 100	100	4"	226524

ZAM3K

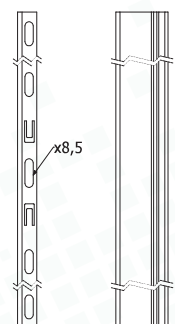

BF2R H105



L = 3 m (10 ft)



	B		B			REF.
	mm	inch	mm	inch		
BF2R 100X105	100	4"	105	4"	0	217363
BF2R 150X105	150	6"	105	4"	0	217364
BF2R 200X105	200	8"	105	4"	1	217365
BF2R 300X105	300	12"	105	4"	1	217366
BF2R 400X105	400	16"	105	4"	1	217367
BF2R 500X105	500	20"	105	4"	2	217369
BF2R 600X105	600	24"	105	4"	2	217370

EZ 1000

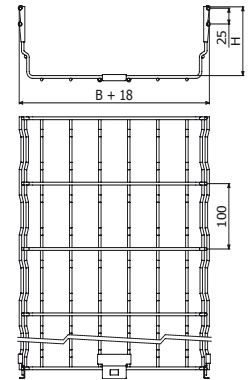

B+EcoD

OPTIMIZED IMPACT SOLUTIONS

FAST
INSTALLATION

TEBFR
(BF2R H105/H150)

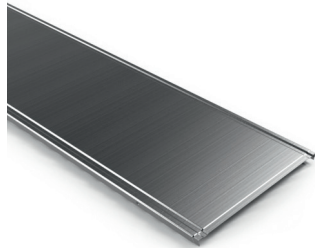

	B		REF.
	mm	inch	
TEBFR 100	100	4"	226878
TEBFR 150	150	6"	226879
TEBFR 200	200	8"	226880
TEBFR 300	300	12"	226881
TEBFR 400	400	16"	226272
TEBFR 500	500	20"	226882
TEBFR 600	600	24"	226883

ZAM3K

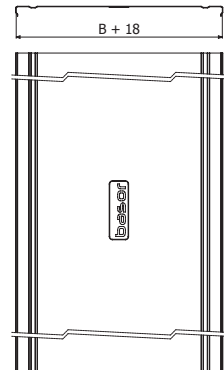

PTBFR



PTBFR



4 x PTBFR => 1 x TERE (BF2R/BFR)

REF.
227974
304

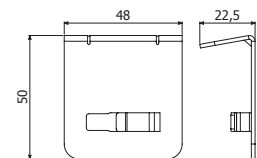
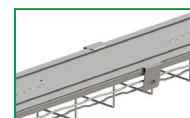

BF2R H150



L = 3 m (10 ft)



	B		B			REF.
	mm	inch	mm	inch		
BF2R 200X150	200	8"	150	6"	2	217363
BF2R 300X150	300	12"	150	6"	2	217364
BF2R 400X150	400	16"	150	6"	3	217365
BF2R 450X150	450	18"	150	6"	3	217366
BF2R 500X150	500	20"	150	6"	3	217367
BF2R 600X150	600	24"	150	6"	4	217369

EZ 1000



B+EcoD

OPTIMIZED IMPACT SOLUTIONS

FAST
INSTALLATION

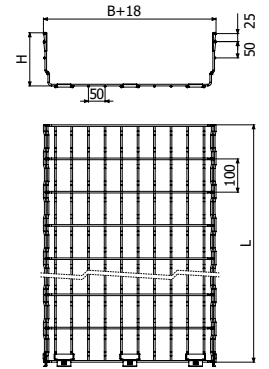

TEBFR (BF2R H105/H150)

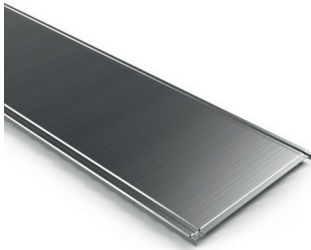

	B		REF.
	mm	inch	
TEBFR 100	100	4"	226878
TEBFR 150	150	6"	226879
TEBFR 200	200	8"	226880
TEBFR 300	300	12"	226881
TEBFR 400	400	16"	226272
TEBFR 500	500	20"	226882
TEBFR 600	600	24"	226883

ZAM3K

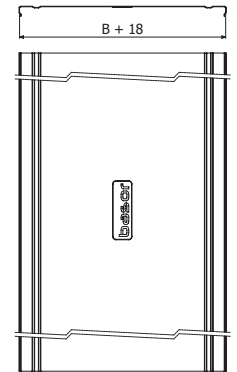

PTBFR



PTBFR



4 x PTBFR => 1 x TERE (BF2R/BFR)

REF.

227974

304

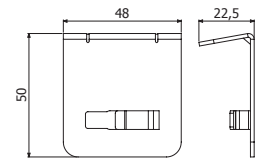
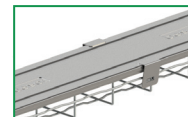

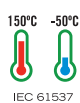

URBF



CGBF



CULA 65/105



CTBF



JUBFR-A

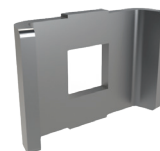

GBF



URCBF



UCBF

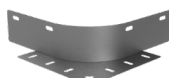

PDBFR



JUER-BFR



MU



SLS



SPBF

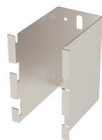

SPVBF



SSC



SST



STBF



PBF



SFS



STBU



CFBFR



STB2



SUC



SUCM



SCBFR



SUCM35



BJC



BJCM



SFL

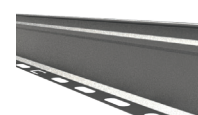

PS



PTBFR

URBF



URBF 65/105

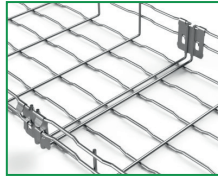

REF.	ZnNi
206219	

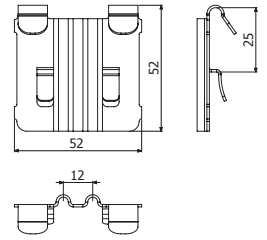

CULA



CULA 65/105

10

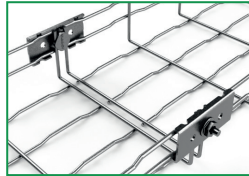

Pap	REF.	ZnNi
N-m	204363	
6		

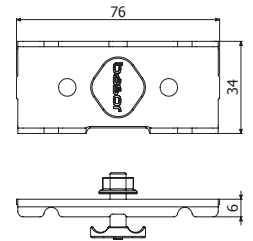

CGBF



CGBF

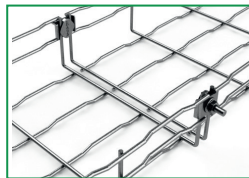

Pap	REF.	ZnNi
N-m	204360	
6		

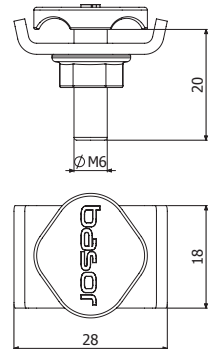

CTBF



CTBF

10

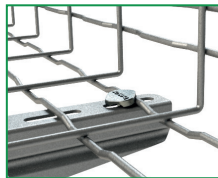

Pap	REF.	ZnNi
N-m	207132	
6		

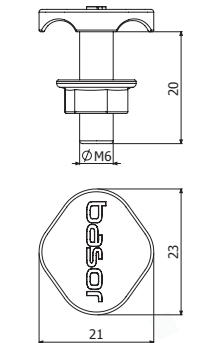

GBF

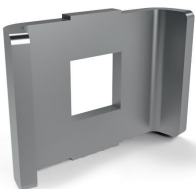

GBF

10

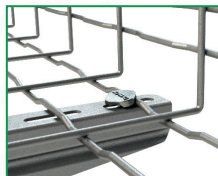

REF.	ZnNi
200339	

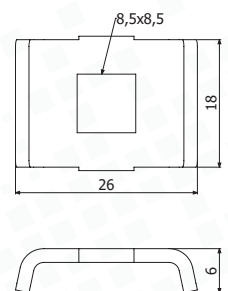

UCBF

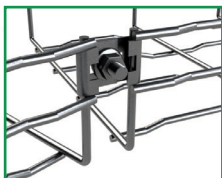

UCBF

10

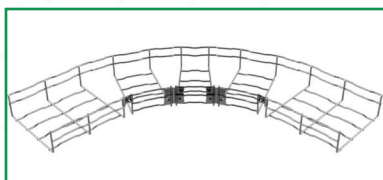

Pop	REF.	Zn/Ni
N.m	205060	
6		

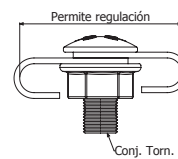
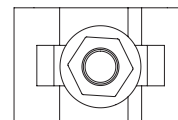

URCBF

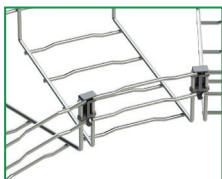

URCBF-100 Pack



Pack 100 u.

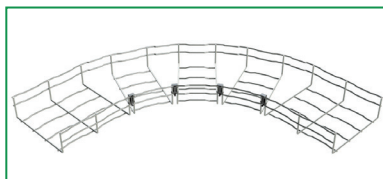

REF.	i304
226135	

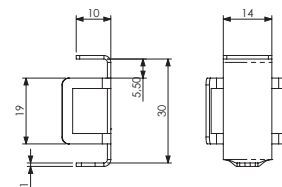
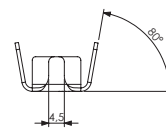

MU



MU 500



2 x CTBF

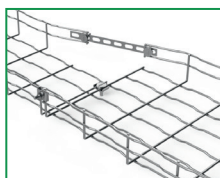

REF.	i304
209872	

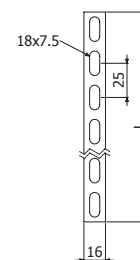

JUBFR-A



JUBFR-A 65/105



2 x GBF (200337-EZ / 200340-i304) + 2/100 x B1 (204356-EZ / 204925-i304)

10



REF.	i304
209869	

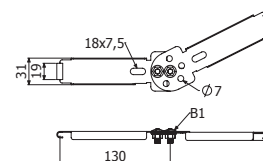

JUER-BFR

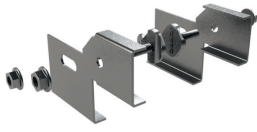

JUER-BFR 60/65

2 x CTBF + 2/100 x B1

10

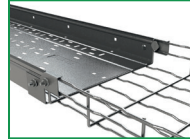

REF.	i:304
209869	

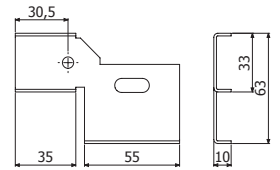

SUC

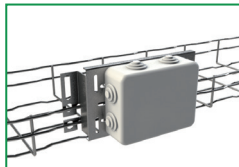
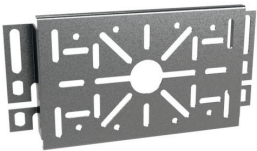

SUC



29-70 mm

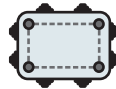

79x50, 98-128x50, 15-55x82



L: 30 - 147

REF.	i:304
200378	

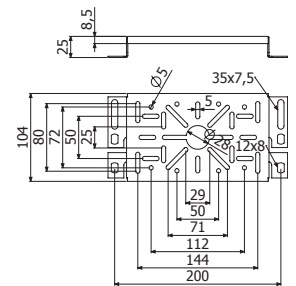

SLS



SLS

BFR/BF2R 60x65 - 100x65

VR6/VR8 - BFR/BF2R 60x65...200x65

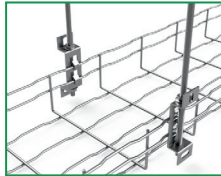
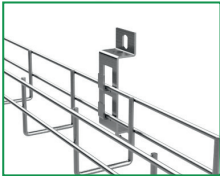

REF.	i304
200380	

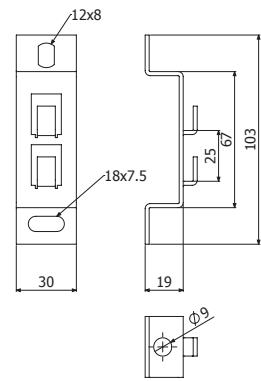

SPBF



SPBF 60-100x35

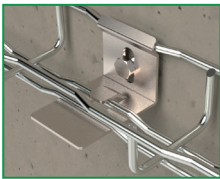

REF.	i304
217595	

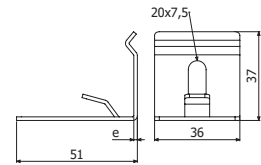

SPVBF

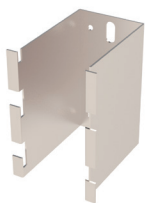

SPVBF 100/70

SPVBF 100/120

H		A		e	REF.
mm	inch	mm	inch	mm	

i304

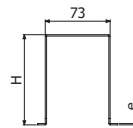
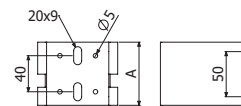

SPVBF 100/70

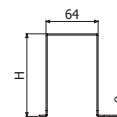
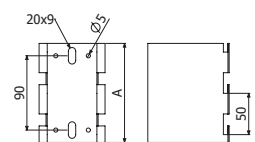

SPVBF 100/120

SSC

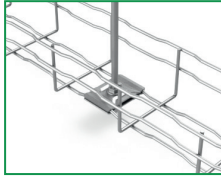
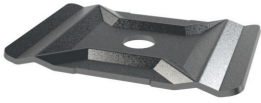

SSC 6

SSC 8/10

10 SSC 8/10 -> M8/M10

60x35, 150x35, 60x65.

2x SSC 8/10 + 2x DIN6923 M8 + BF2R/BFR (B<=200mm)

D	REF.	Zn/Ni
mm		
7,5	218760	
10,5	200373	

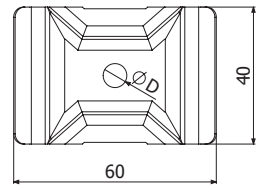
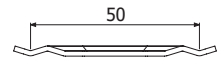

SST



SST

VR8/VR10

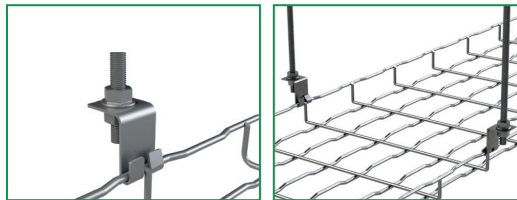

D	REF.	i316
mm		
10,5	218803	

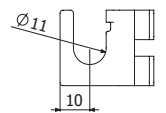
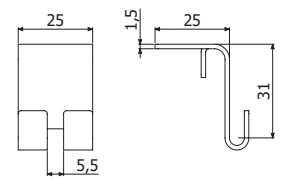

SCBFR



SCBFR 1KG



SCBFR 3.5 KG



NO DRILL NEEDED



B= 60-150 --> 1 x SCBFR 1kg / 1 x SCBFR 3,5 kg (long.)
 B= 200 --> 1 X SCBFR 1kg Alternate position / 1 x SCBFR 3,5 kg
 B= 300 - 400 --> 2 x SCBFR 1kg / 1 x SCBFR 3,5 kg (alt.pos B:400)
 B= 500 - 600 --> 2 x SCBFR

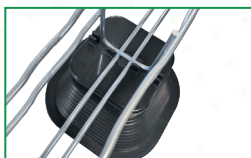

REF.	RLH
223328	
225777	

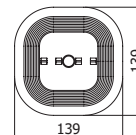
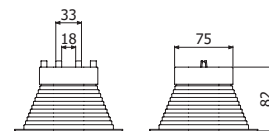

PBF

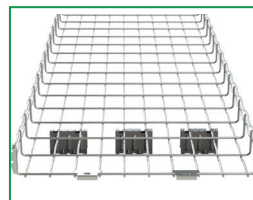
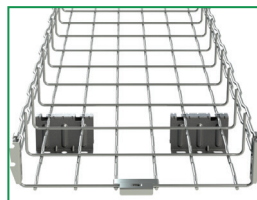
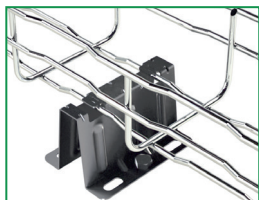
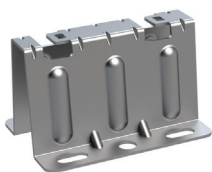

PBF	e	CTA		REF.	i304
	mm	kg	lb		
	1	250	551	223328	

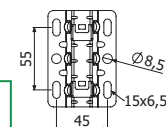
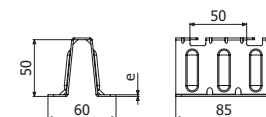

C-SVO



TFSO

	B		e	CTA		REF.	i304
	mm	inch	mm	kg	lb		
C-SVO100	100	4"	1,5	250	552	206285	
C-SVO150	150	6"	1,5	200	441	201087	
C-SVO200	200	8"	1,5	294	649	201088	
C-SVO300	300	12"	1,5	235	519	201090	
C-SVO400	400	16"	1,5	161	355	206286	
C-SVO450	450	18"	-	115	254	-	
C-SVO500	500	20"	1,5	115	254	206287	
C-SVO600	600	24"	1,5	87	192	206288	
TFSO (PVC)	-	-	-	-	-	200894	

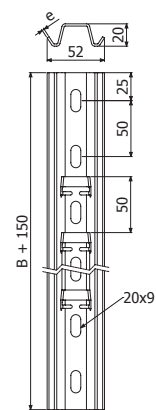

CFBFR41



SP2, SP4, SP3S, 41/82

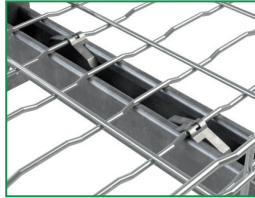

REF.	i304
CFBFR41	210284

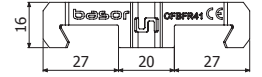
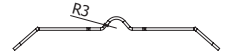

STB2

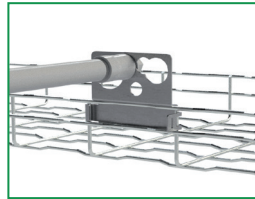

REF.	i304
STB2 12-32	218800

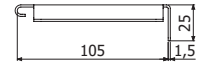
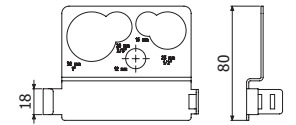

SUCM

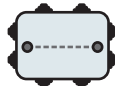
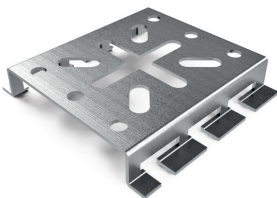

L: 30 -48

REF.	i304
SUCM	200379

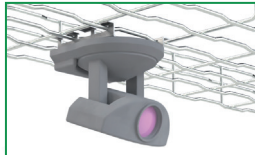
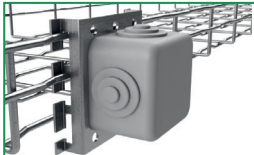
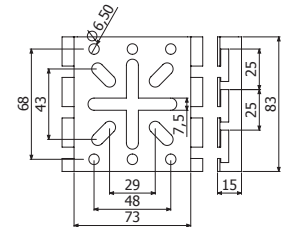

TFBFR



TFBFR-100

REF.

228728

PVC

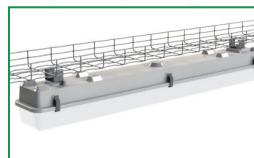
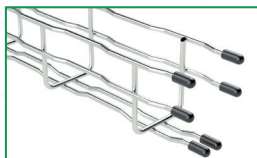
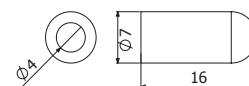

TDC



BPZ



BPHDG

Herramienta de corte TDC

REF.

205066

BPZ Pintura zinc brillante 400 ml

207224

BPHDG Reparador galvanizado en caliente (96% Zn) 500 ml

225464

TT / TTL

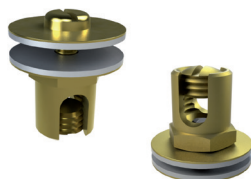

TT

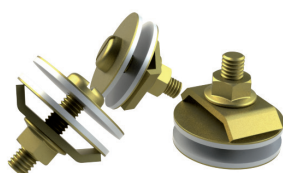

TTL

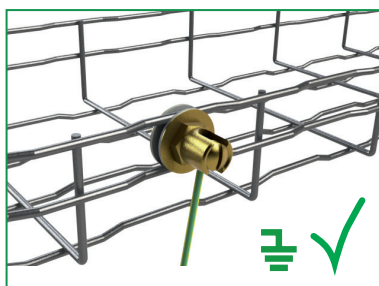

	Smin	Smax	Dcable	A	B	REF.	
	mm ²	mm ²	mm	mm	mm		
TT 4-35	4	35	2,2 a 8	22	18	206796	LTN
TT 35-95	35	95	8 a 12	30	24	206797	
TTL 10-35	10	35	4 a 8	25	-	208189	

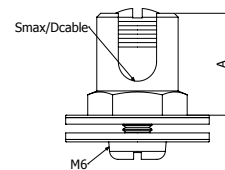

TT

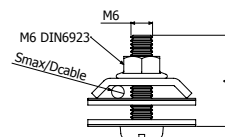
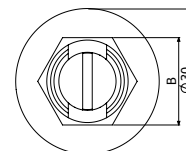

TTL

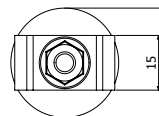

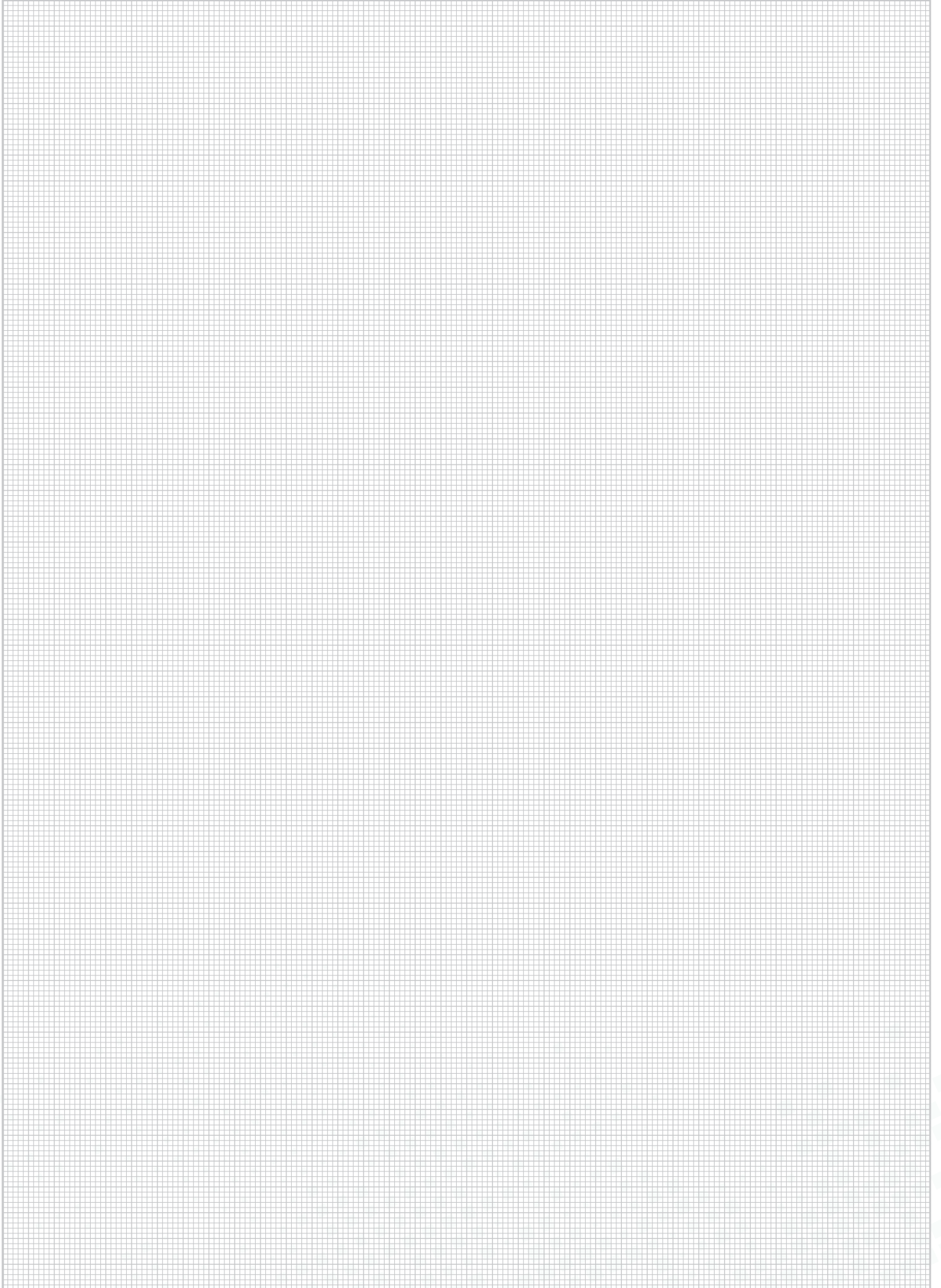



BasorsSupport

C-SHO



C-SHO



	B		e	SWL		REF.
	mm	inch		kg	lb	
C-SHO100	100	4"	1,5	105	231	229043
C-SHO150	150	6"	2	100	220	229044
C-SHO200	200	8"	2	81	178	229045
C-SHO300	300	12"	2	45	99	229046
C-SHO400	400	16"	2	27	59	229047

ZAM3K

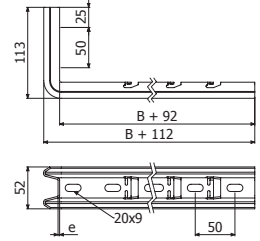

C-SHO

SCR

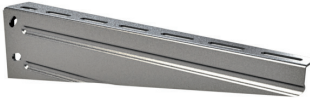

	B		e	SWL		REF.
	mm	inch		kg	lb	
SCR 100	100	4"	1,5	104	229	226638
SCR 150	150	6"	1,5	80	176	226639
SCR 200	200	8"	1,5	70	154	226640
SCR 300	300	12"	2	85	187	226641
SCR 400	400	16"	2	80	176	226642
SCR 500	500	20"	2	105	231	226643
SCR 600	600	24"	2	90	198	226644

ZAM3K

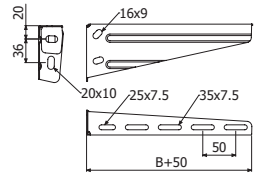

**SCR
100/200/300/400**

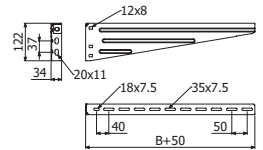

**SCR
500/600/750**

KS

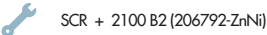
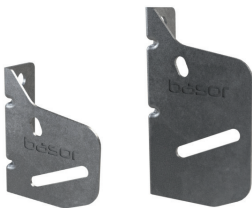

KS+SCR

	H		REF.
	mm	inch	
KS 50_400	76	3"	210049
KS 500_750	94	3 3/4"	218077

i304

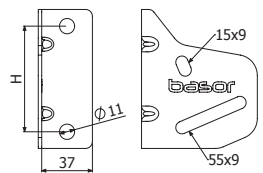

C-SVO



	B		e		SWL		REF.	ZAM3K
	mm	inch	mm	kg	lb			
C-SVO 100	100	4"	1,5	250	552	226646		
C-SVO 150	150	6"	1,5	200	441	226647		
C-SVO 200	200	8"	2	294	649	226648		
C-SVO 300	300	12"	2	235	519	226649		
C-SVO 400	400	16"	2	161	355	226650		
C-SVO 450	450	18"	2	115	254	-		
C-SVO 500	500	20"	2	115	254	226651		
C-SVO 600	600	24"	2	87	192	226652		

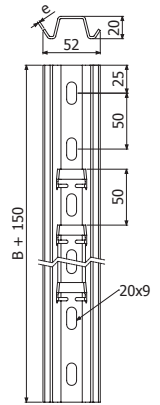

2 x DIN976 M8x1000 (206852-i304) + 4 x DIN6923 M8 (217555-i304)
 B1(206826-ZnNi)

P41-3S 41X41



L=3m (10ft)



TF41

	e	REF.	ZAM3K
	mm		
P41-3S 41X41X2	2	226940	
TF41 PVC	-	205627	

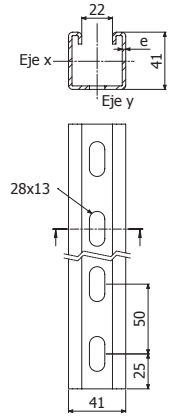

B1



	L		REF.	ZnNi
	mm	N•m		
B1-100 Pack	100u	14	6	206826

10

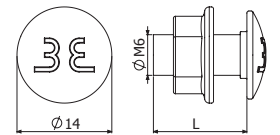

B2



	100u	P _{ap}		REF.	ZnNi
		N•m			
B2 Pack 100u	100u	15	206792		

13

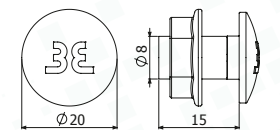

BE Basor

CABLE TRAY SPECIALIST

Basor Electric S.A

Avenida Alcodar, 45
Polígono Industrial Alcodar, 46701
Gandia (Valencia) - España
Tel. +34 96 287 66 95

www.basor.com / basor@basor.com